

Fingerprint Access Control/Attendance Time Clock

Installation Manual

Rev: 1.0

Contents

I.	BEFORE INSTALLATION	- 3 -
1.1	PRECAUTIONS OF INSTALLATION.....	- 3 -
1.2	PANEL OVERVIEW	- 4 -
1.3	PACKAGING LIST	- 5 -
1.4	OTHER PARTS.....	- 6 -
II.	SYSTEM STRUCTURE.....	- 7 -
2.1	DIAGRAM OF SYSTEM INSTALLATION	- 7 -
2.2	DIAGRAM OF COMMUNICATION CONNECTION	- 7 -
III.	INSTALLATION	- 9 -
3.1	DETAILED INSTALLATION	- 9 -
3.2	CONNECTING PERIPHERAL EQUIPMENT.....	- 10 -
3.2.1	<i>Magnetic door detector</i>	- 11 -
3.2.2	<i>Open button</i>	- 11 -
3.2.3	<i>Alarm</i>	- 11 -
3.2.4	<i>Doorbell</i>	- 11 -
3.2.5	<i>Door lock</i>	- 11 -
3.2.6	<i>Ethernet connection</i>	- 14 -
3.2.7	<i>RS485 connection</i>	- 15 -
3.2.8	<i>Full function connection of the Fingerprint Access Control/Attendance Time Clock</i>	- 16 -
IV.	EXAMINATION AFTER INSTALLATION	- 17 -
V.	ANTI-TAMPER SWITCH	- 18 -
VI.	TROUBLESHOOTING	- 19 -

I. Before installation

1.1 Precautions of installation

Before installing, please read the installation precautions of the Fingerprint Access Control/Attendance Time Clock carefully. Proper operation will improve the effect and speed significantly. **If you don't read the following precautions before installing, it may cause accident because of improper installation.**

1. Before installing, please make sure that the **power supply is cut off**. It is dangerous to operate if the power supply is connected and the device or even the core parts will be damaged because of the contact of power cord.
2. The bare parts of all connection terminals shouldn't exceed **5mm** to prevent accident contact and damage the device because the bare wire is too long. You also need to use connection cables of different colors.
3. To install the device at places with serious static electricity or in dry season, please **connect the ground wire first and then other cables** to avoid damaging the device because of large transient static electricity.
4. **Connect all cables before connecting the power cord**. If the device can't work normally, please cut off the supply and then check the device. Please note that any operation when the power supply is connected may damage the device, and the warranty doesn't cover the damage caused by such operation.
5. The appropriate installation height of the device is **1.4-1.5m**.
6. After installation, please **take off the protective film on the fingerprint collector** to ensure best recognition effect.
7. Test the open switch when there is person outdoor, because accident may occur and you can't go out normally.
8. **12V DC** power supply is recommended for this device. 2A/12VDC electric lock

is recommended. Please contact qualified technical personnel if the power supply parameters of the lock exceed this range. If the power supply doesn't reach this requirement, it may can't drive the electric lock and even damage the device.

9. To connect the wires for the Fingerprint Access Control/Attendance Time Clock, please follow the Installation Manual strictly. The warranty doesn't cover the damages of the core parts and the fingerprint collector caused by improper connection.
10. If the distance between the power supply and the device is far, do not connect with network cable or other cables. To select power cord, the voltage attenuation because too long transmission distance should be considered.
11. To network in 485-mode, please use professional 485-cable and activate RS232/485 converter and wire in general line structure. If the distance of RS485 communication exceeds 100m, please add terminal matching resistor at the start terminal device and the end terminal device of the RS485 bus. **The resistance is about 120Ω.**
12. For other matters, please refer to the Installation Manual and Hardware Manual of the device.

1.2 Panel overview



1. ① LED indicator: the red indicator is constantly on when the device is working normally. The green indicator lights for three seconds if the validation passes and won't light if the validation doesn't pass.
2. ② Display: display time and characters, making it convenient for the user to collect the operating information of the Fingerprint Access Control/Attendance Time Clock.
3. ③ Keypad: press to input figures and operate menus.

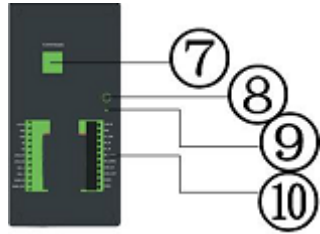

4. ④ Doorbell button: notify the people inside the door that there is visitor.
5. ⑤ Fingerprint collector: Record or compare fingerprints.
6. ⑥ Card reading position: Sensing area of ID card.
7. ⑦ RJ45 interface: connect network cable.
8. ⑧ Anti-tamper switch: the switch is pressed down when it is installed and it alarms when released.
9. ⑨ Power off button: press to turn off the device.
10. ⑩ Connector: connect power supply, peripheral equipment, access controller, networking communication, etc.











1.3 Packaging list

Unit	Picture	Quantity	Purpose
Fingerprint Access Control/Attendance Time Clock		1	
Installation template		1	To fix the installation position, drill holes and distribute wire before installation

Screw		4	To fix the Fingerprint Access Control/Attendance Time Clock
Manual		2	Installation Manual and User Manual

1.4 Other parts

The following parts are mentioned in this Manual but aren't included in the standard configuration.

Unit	Picture	Unit	Picture
Computer		Door lock	
Magnetic door detector		Open switch	
Alarm		485 converter	
Access controller		Network cable	
Doorbell			

II. System structure

2.1 Diagram of system installation

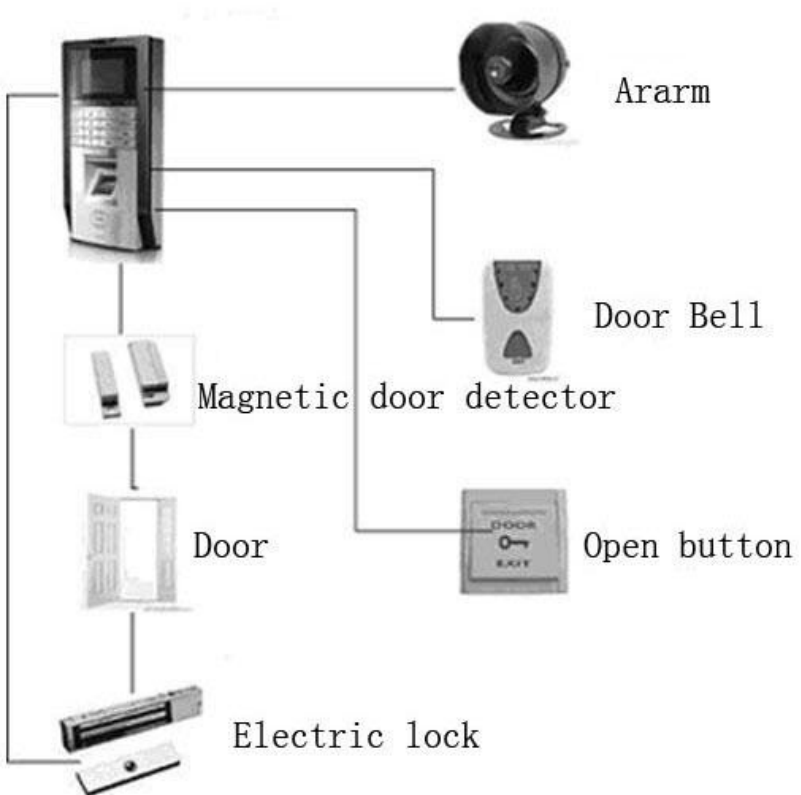

2.2 Diagram of communication connection

1) The Fingerprint Access Control/Attendance Time Clock networks with the PC through RS485:



2) The Fingerprint Access Control/Attendance Time Clock networks with the PC through TCP/IP:

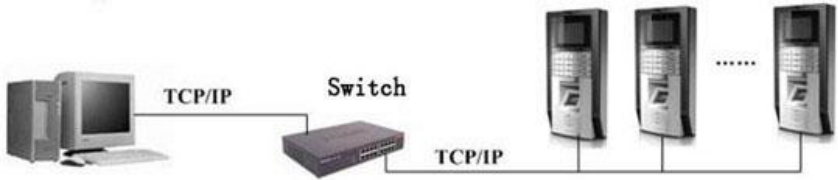

III. Installation

3.1 Detailed installation

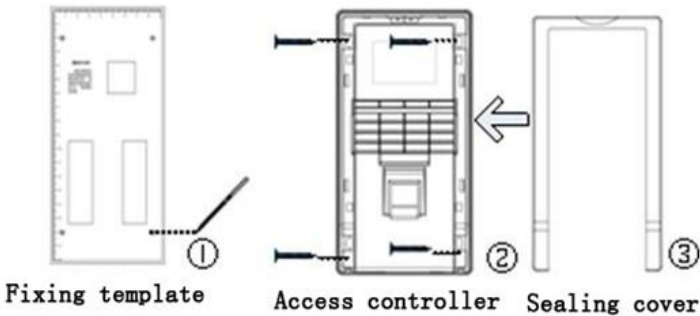

- 1) Confirm the installation position of the Fingerprint Access Control/Attendance Time Clock. The device should be installed on the wall outside the entrance at the height about 1.4m.
- 2) Take out the provided installation template and paste it on the position where the device will be installed. Refer to Fig.① and leave holes.
- 3) Use percussion drill or other tools to drill holes in the wall and tighten plastic expansion screws into the holes.
- 4) Take out the Fingerprint Access Control/Attendance Time Clock, refer to the Bottom Plan of the Access Controller below to prize up and remove the sealing cover (Fig.③) with a slotted screwdriver from the small gaps on both sides of the access controller.

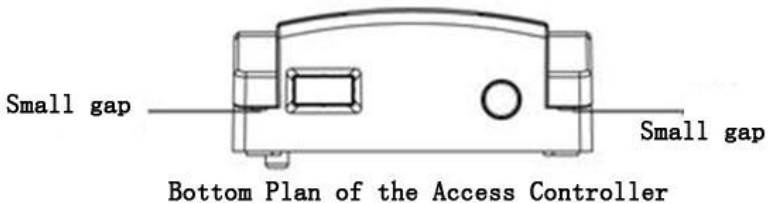

- 5) **Refer to section 3.2 to connect the peripheral equipment.** After connecting the wires, please test the Fingerprint Access Control/Attendance Time Clock and peripheral equipment.
- 6) Refer to Fig. ② and fix the Fingerprint Access Control/Attendance Time Clock with provided screws.
- 7) Put on the sealing cover.

3.2 Connecting peripheral equipment

Before connecting, please make sure that the power supply has been cut off. It may damage the device if the wires are connected in electrified state. Refer to the following table to connect peripheral equipment.

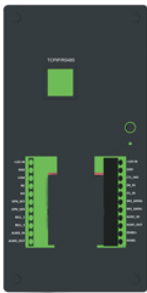

Interface definition (Left)	Interface definition (right)
DC input (+12V)	DC input (+12V)
Earth wire (GND)	Earth wire (GND)
Power input of the lock (COM)	Signal input (CTL-IN)
Normal open output of the lock (NO)	WG DO input (D0-IN)
Normal closed output of the lock (NC)	WG D1 input (D1-IN)
Go out button input (OPEN-KEY)	WG data 0 output (WG-DATA0)
Magnetic door detector input (SEN)	WG data 1 output (WG-DATA1)
Doorbell input (BELL-IN)	Alarm 1 input (ALM1-IN)
Doorbell output (BELL-OUT)	Alarm 1 output (ALM1-OUT)
Alarm 0 input (ALMO-IN)	485A
Alarm 0 output (ALMO-OUT)	485B

3.2.1 Magnetic door detector

The magnetic door detector is used to detect the state of the door. This Fingerprint Access Control/Attendance Time Clock can detect whether the door is opened illegally through the detector. If the door is opened illegally, the device sends alarm signal. In addition, if the door isn't closed in specified time after opening, it also sends alarm signal.

3.2.2 Open button

The Open button is the door switch device installed in the room. The door opens when this button is closed. The Open button is fixed on the wall in the room at the height about 1.4m from the floor. The Open button should be protected from electromagnetic disturbance (e.g. the lighting switch and PC will cause electromagnetic disturbance).

3.2.3 Alarm

It is also called burglar alarm. It is a general designation of the electronic products that alarm in sound, light or air pressure for accidents, dangers and emergencies.

3.2.4 Doorbell

The doorbell terminal of this device is directly connected to the doorbell button on the panel. You just need to connect the existing doorbell button cable to corresponding terminal in the device.

3.2.5 Door lock

The installation of the door lock depends on its type and the influence caused by the line resistance should be considered to select power cord for the lock. Make sure the door lock is fixed and the connection is proper. For electric bolt and

magnetic lock, please make sure that the polarity is correct. If there is any cable left, please cut off the bare end and wrap with insulation adhesive tape separately.

Selecting door lock: for glass double-door (open either inside or outside), please select **electric bolt**. For wood single door in offices (open only inside or outside), please select **magnetic lock**. The magnetic lock is also called electromagnetic lock and its stability is higher than electric bolt, but the electric bolt has higher security. In communities, it's better to use magnetic lock and electric bolt. The electric bolt makes louder noise. Generally, most buildings use electric bolt. The protection measures against rain are necessary for both magnetic lock and electric bolt. Other electric locks are not recommended.

Connecting electric bolt: This Fingerprint Access Control/Attendance Time Clock supports both normal open and normal closed door locks. The lock that opens when electricity is connected and closes when electricity is cut off is called normal closed lock and the control end is connected to NC terminal. The lock that closes when electricity is connected and opens when electricity is cut off is called normal open lock and the control end is connected to NO terminal.

The operating voltage of this Fingerprint Access Control/Attendance Time Clock is DC 12V and the operating current is about 350mA.

The following are several wiring methods of locks (the first is recommended for normal closed locks and the second is recommended for normal open locks):

Connection diagram of electric lock

1) Normal closed lock (share power supply with Fingerprint Access Control / Attendance Time Clock)

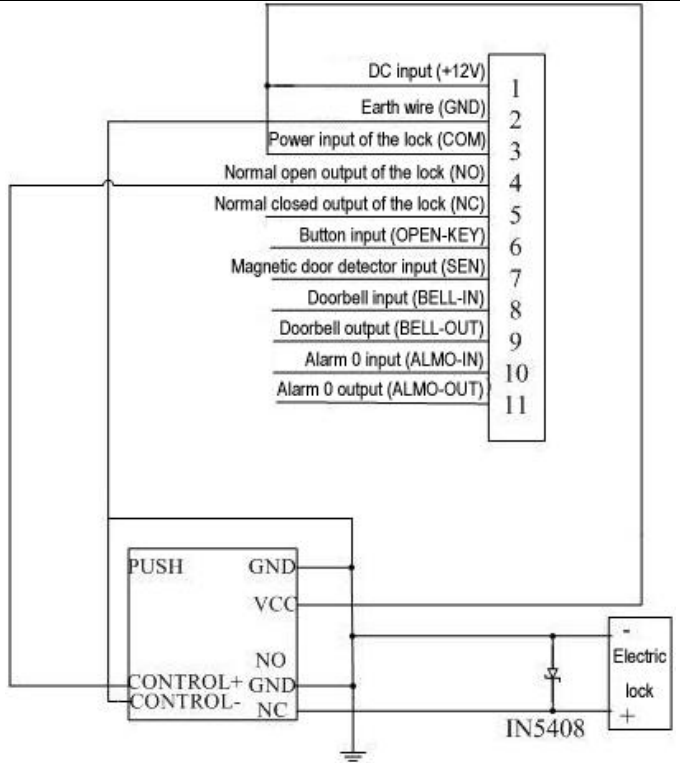

2) Normal open lock (share power supply with Fingerprint Access Control / Attendance Time Clock)

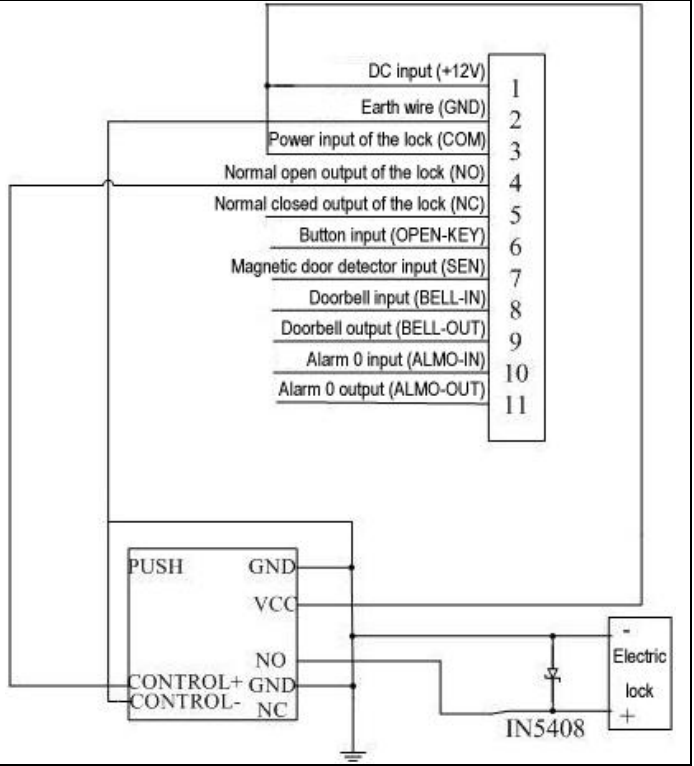

3.2.6 Ethernet connection

1) The Fingerprint Access Control/Attendance Time Clock is connected to the PC through crossover cable:

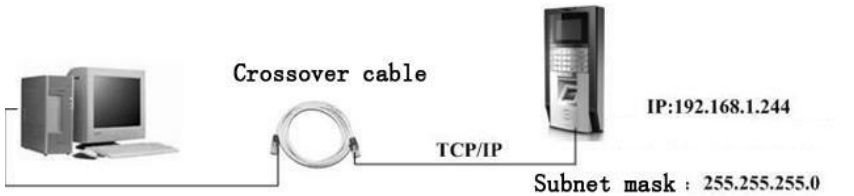



2) The Fingerprint Access Control/Attendance Time Clock is connected to the PC through switch/hub with straight-through cable.

3.2.7 RS485 connection

To network with RS485, it is necessary to wire in general line network structure. RS485 cable is made of a group of twisted pair cables and transmits signals through the voltage difference between the two communication cables. The signals cause differential mode interference between the two cables in the transmission process. To eliminate differential mode interference, add terminal matching resistor between start terminal device and end terminal device of RS485 bus. The resistance is 120Ω. (It is not necessary to add generally)

The definition of terminal sideline:

RS485 converter	Connection terminal of access controller
A+	485A
B-	485B



3.2.8 Full function connection of the Fingerprint Access Control/Attendance Time Clock

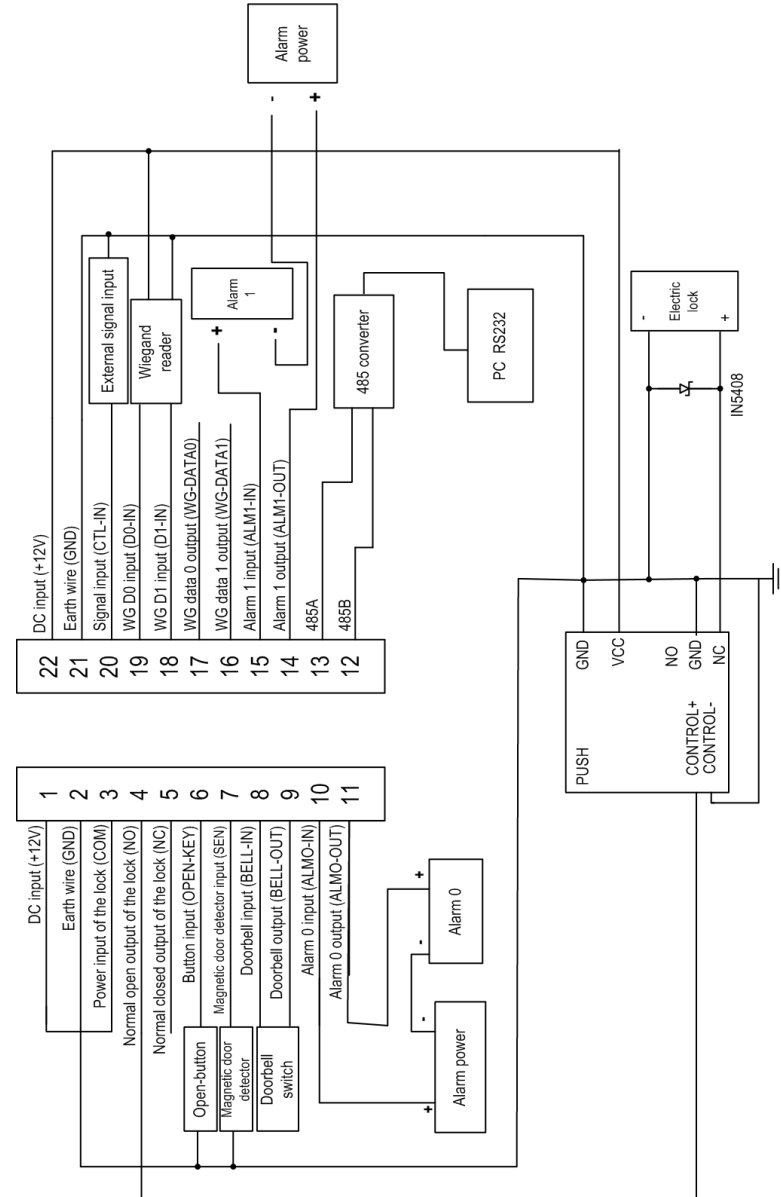

Note: IN5408 is anti-spark diode, which must be reversed to the anode and cathode of the electric lock and close to electric lock as much as possible.

IV. Examination after installation

After installing the system, please check the installation before connecting the electricity. Connect the power supply if there is no problem, and then press the switch to turn on the Fingerprint Access Control/Attendance Time Clock.

- 1) The red LED is on when the Fingerprint Access Control/Attendance Time Clock is turned on.
- 2) Access [Menu] -> [Enroll] -> [User] -> [Finger] and register a fingerprint. Test the access controller and door lock through fingerprint validation.
- 3) If there is no problem, delete the registered fingerprint.

V. Anti-tamper switch

The anti-tamper switch is in the center right of the Fingerprint Access Control/Attendance Time Clock (see Section 1.2 Panel overview). Press the anti-tamper switch on the wall while installing the Fingerprint Access Control/Attendance Time Clock. When the device is removed, the access controller sends alarm signals. Refer to Section 3.2.8 Full function connection of the Fingerprint Access Control/Attendance Time Clock for the connection of alarm.

VI. Troubleshooting

Fault	Reason and solution
The power LED (red) isn't lighted	<p>Reason:</p> <p>1) No power supply or voltage is low</p> <p>Solution:</p> <p>① Make sure that the power cord of the device and the earth wire are in good condition;</p> <p>② Test the voltage and make sure that it is 12VDC.</p>
The Fingerprint Access Control/Attendance Time Clock can't communicate with the PC	<p>Reason:</p> <p>1) The connection cable has problem</p> <p>Solution:</p> <p>Check whether the RS485 cable and the TCP/IP cable are in good condition.</p>
The Fingerprint Access Control/Attendance Time Clock repeats prompting "Please repress your finger!"	<p>Reason:</p> <p>1) After long term using, the fingerprint collector is dirty or damaged and has scratch, and the fingerprint collector considers it as fingerprint, but the validation isn't passed after comparison.</p> <p>Solution:</p> <p>① Use adhesive fabric to stick the dirt on the surface of the fingerprint collector.</p> <p>② Contact the supplier and request for warranty.</p>
The time is incorrect	<p>Reason:</p>

<p>when the device is restarted after power failure</p>	<p>1) The clock battery is damaged. 2) The battery has no electricity.</p> <p>Solution: Change a new battery</p>
<p>The indicator of the fingerprint collector isn't lighted</p>	<p>Reason: 1) The data cable of the fingerprint collector isn't connected properly. 2) The fingerprint collector is damaged.</p> <p>Solution: Contact the supplier and request for warranty.</p>
<p>No sound when press the keys or fingerprint</p>	<p>Reason: 1) The buzzer, speaker or circuitry has problem.</p> <p>Solution: Contact the supplier and change the buzzer or speaker.</p>
<p>Certain users often can't pass the fingerprint validation</p>	<p>Reason: The lines of the fingerprint aren't clear</p> <p>Solution: When register fingerprint, please select the finger with high quality fingerprint (few wrinkle, no skin rising, clear fingerprint). Try to contact the fingerprint collector with larger area. Test the fingerprint after registration. The device also provides the following comparing modes: 1:1, password registration and sensor card registration.</p>